

**97** mm**San Ace B97****General Specifications**

- Material ..... Frame: Plastics (Flammability: UL94V-0),  
Impeller: Plastics (Flammability: UL94V-0)
- Expected Life ..... Refer to specifications (L10:Survival rate: 90% at 60°C,  
rated voltage, and continuously run in a free air state)
- Lead Wire ..... ⊕red ⊖black (Sensor) yellow
- Storage Temperature ..... -30°C to +70°C (Non-condensing)

**97 mm × 33 mm** (Mass : 175g) **9BM type****Specifications** The following nos. **have pulse sensors.**

Model No.	Rated Voltage [V]	Operating Voltage Range [V]	Rated Current [A]	Rated Input [W]	Rated Speed [min <sup>-1</sup> ]	Max. Airflow [m <sup>3</sup> /min] [CFM]	Max. Static Pressure [Pa] [inchH <sub>2</sub> O]	SPL [dB(A)]	Operating Temperature [°C]	Expected Life [h]
<b>109BM12GC2-1</b>	12	7 to 13.8	0.60	7.20	3,800	0.82 28.9	281 1.129	51.5	-20 to +70	40,000/60°C (70,000/40°C)
<b>109BM12HC2-1</b>			0.40	4.80	3,300	0.71 25.1	204 0.819	48.5		
<b>109BM12MC2-1</b>			0.26	3.12	2,700	0.58 20.5	119 0.478	43.5		
<b>109BM24GC2-1</b>	24	12 to 27.6	0.31	7.44	3,800	0.82 28.9	281 1.129	51.5		
<b>109BM24HC2-1</b>			0.26	6.24	3,300	0.71 25.1	204 0.819	48.5		
<b>109BM24MC2-1</b>			0.15	3.60	2,700	0.58 20.5	119 0.478	43.5		

Other sensor specifications are available as options. Please refer to the index (p. 495).

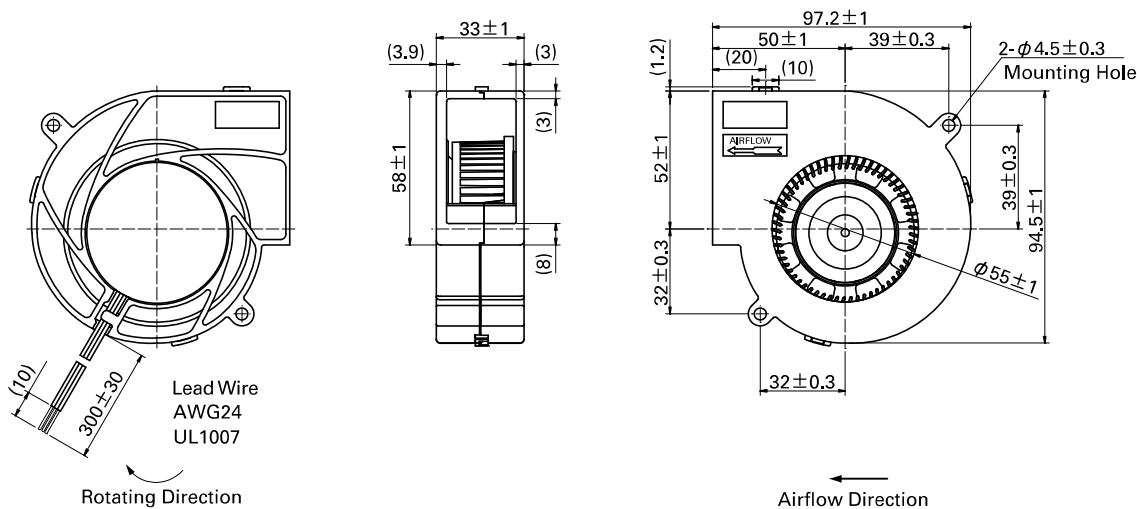
**Dimensions (unit: mm)**

# Airflow - Static Pressure Characteristics

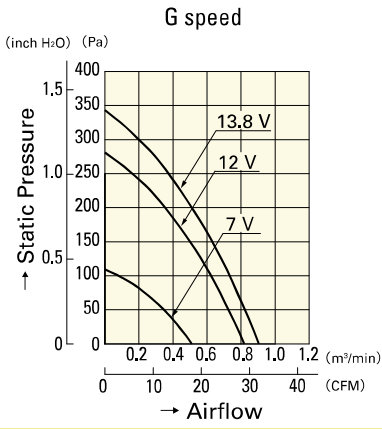

**109BM12GC2-1**

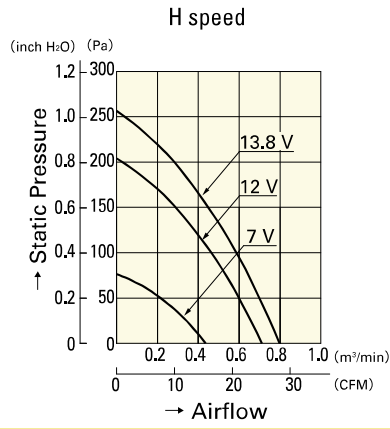

**109BM12HC2-1**

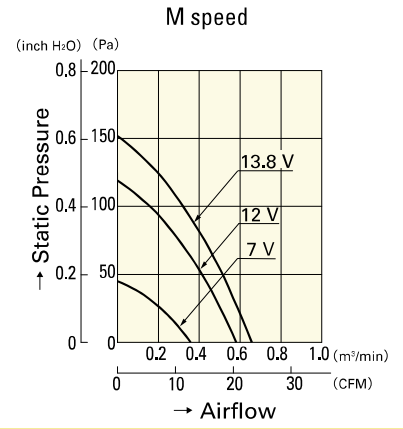

**109BM12MC2-1**

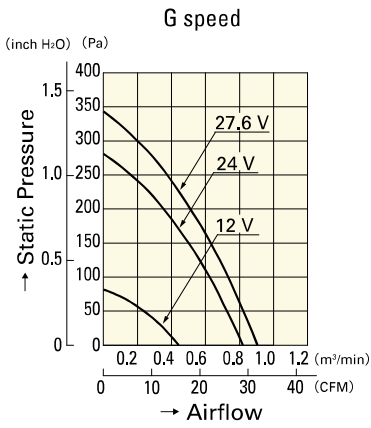

**109BM24GC2-1**

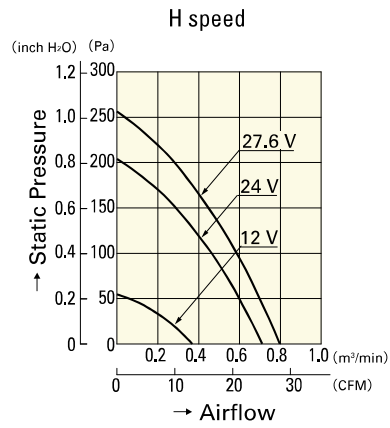

**109BM24HC2-1**

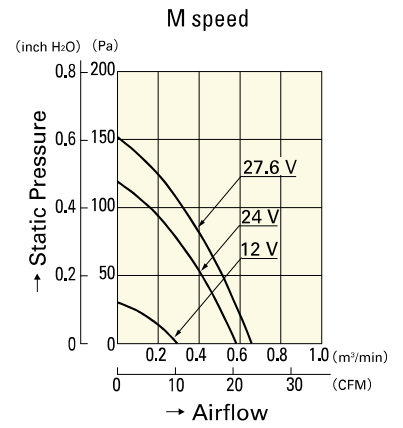

**109BM24MC2-1**

**DC**

**Blower 97mm**