

60 mm sq.

San Ace 60W



General Specifications

- Material Frame: Aluminum (Black coating),
Impeller: Plastics (Flammability: UL94V-1)
- Expected Life Refer to specifications (Indoor, L10:Survival rate:90% at 60°C ,
rated voltage, and continuously run in a free air state)
- Lead Wire ⊕red ⊖black (Sensor) yellow (Control) brown
- Storage Temperature -30°C to +70°C (Non-condensing)

60×60×25 mm [Mass : 110g] **IP 68** **9WL** type **High Airflow Long Life Fan**

Specifications

The following nos. have PWM controls and pulse sensors.

Model No.	Rated Voltage [V]	Operating Voltage Range [V]	PWM duty cycle [%]	Rated Current [A]	Rated Input [W]	Rated Speed [min ⁻¹]	Max. Airflow [m ³ /min] [CFM]	Max. Static Pressure [Pa] [inchH ₂ O]	SPL [dB(A)]	Operating Temperature [°C]	Expected Life [h]		
9WL0612P4S001	12	10.8 to 13.2	100	0.67	8.04	11,000	1.40 49.4	300 1.204	53	-20 to +70	180,000/60°C		
			20	0.06	0.72	2,900	0.36 12.7	20.8 0.083	20				
9WL0612P4J001			100	0.39	4.68	8,650	1.10 38.8	182 0.730	47				
			20	0.03	0.36	1,150	0.13 4.8	3.3 0.013	14				
9WL0612P4H001			100	0.17	2.04	6,150	0.78 27.5	97 0.389	36				
			20	0.03	0.36	1,350	0.17 6.0	4.7 0.018	14				
9WL0624P4S001			24	21.6 to 26.4	100	0.34	8.16	11,000	1.40 49.4			300 1.204	53
					20	0.03	0.72	2,900	0.36 12.7			20.8 0.083	20
9WL0624P4J001	100	0.19			4.56	8,650	1.10 38.8	182 0.730	47				
	20	0.02			0.48	2,200	0.28 9.8	12.0 0.048	17				
9WL0624P4H001	100	0.08			1.92	6,150	0.78 27.5	97 0.389	36				
	20	0.02			0.48	1,300	0.16 5.6	4.3 0.017	14				

Note: Fan does not rotate when PWM duty cycle is 0%.

※PWM Frequency : 25kHz

Other sensor specifications are available as options. Please refer to the index (p. 511).

Dimensions (unit: mm)

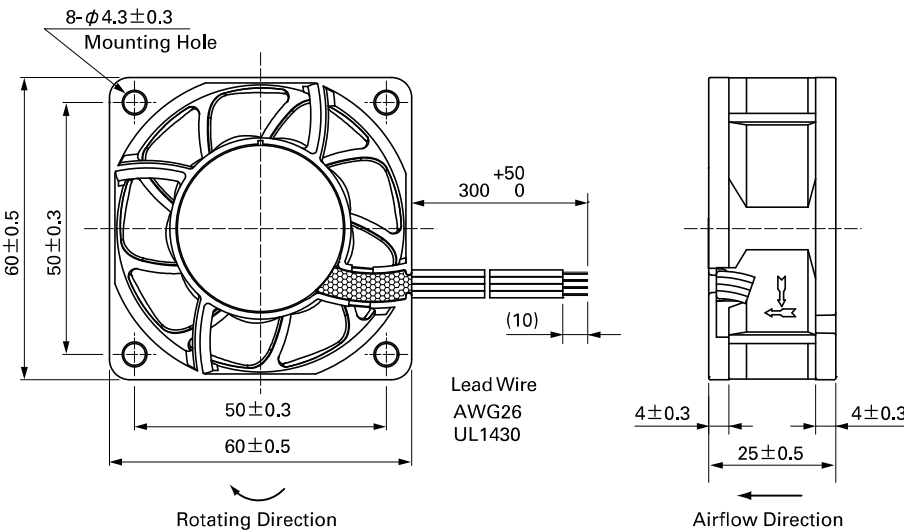

Reference Dimensions of Mounting Holes and Vent Opening (unit: mm)

Inlet side, Outlet side

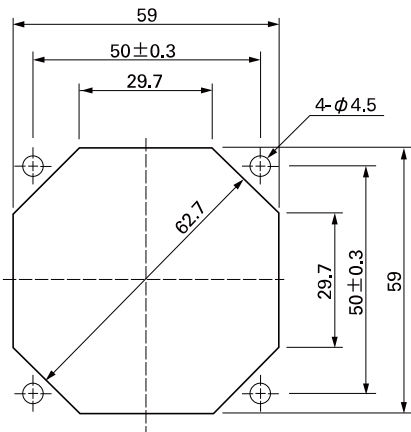

Options (unit: mm)

Finger Guards

Model : 109-139E Surface treatment : Nickel-chrome plating (silver)
 : 109-139H : Cation electropainting (black)

Color

Inlet side, Outlet side

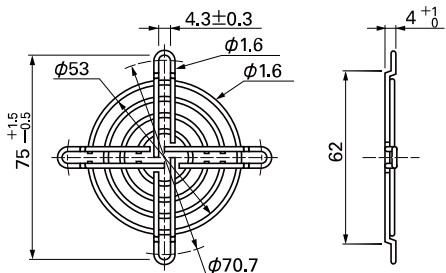

Mass : 14.5g

Resin Finger Guards

Model : 109-1003G

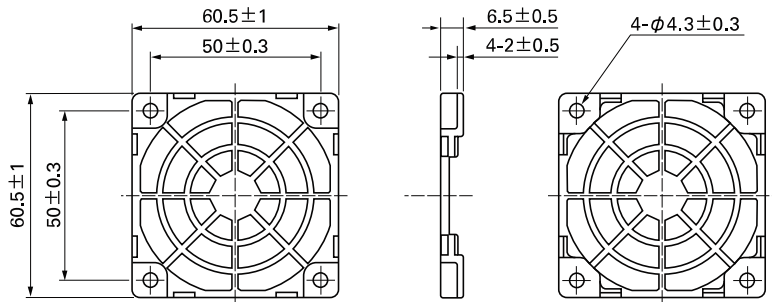

Mass : 7g

60mm sq.

San Ace 60W

60×60×25mm [Mass : 120g]

Airflow - Static Pressure Characteristics

PWM Duty Cycle

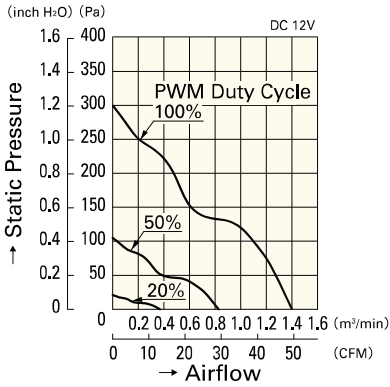

9WL0612P4S001

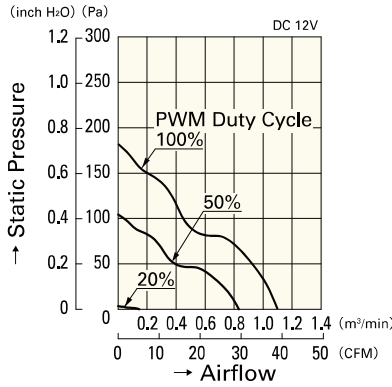

9WL0612P4J001

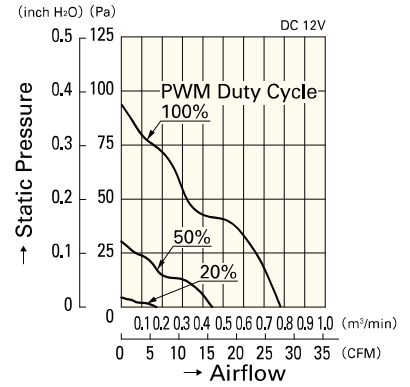

9WL0612P4H001

Operating Voltage Range

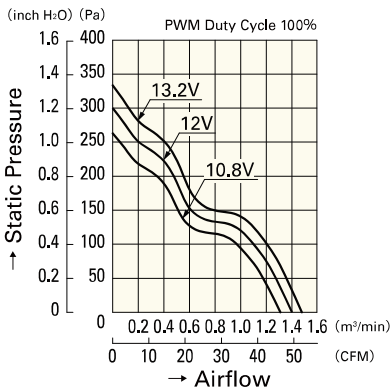

9WL0612P4S001

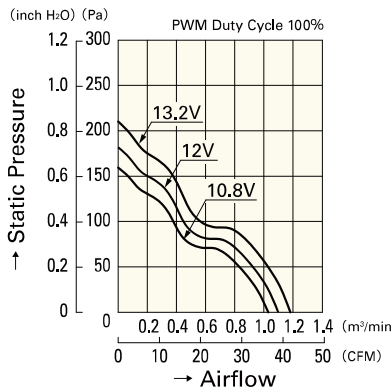

9WL0612P4J001

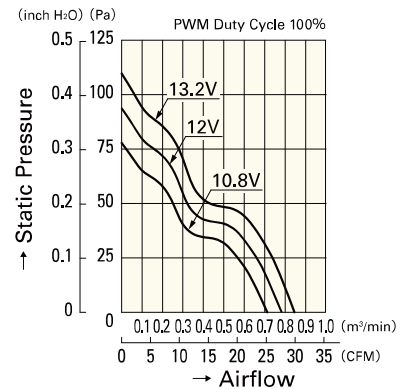

9WL0612P4H001

PWM Duty - Speed Characteristics Example

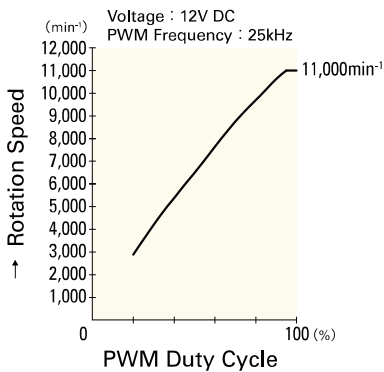

9WL0612P4S001

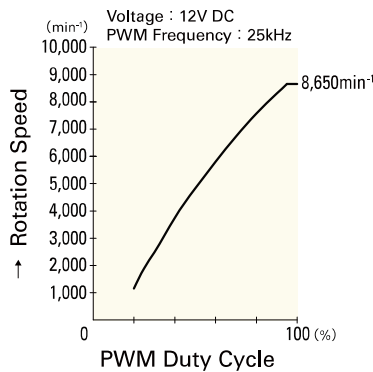

9WL0612P4J001

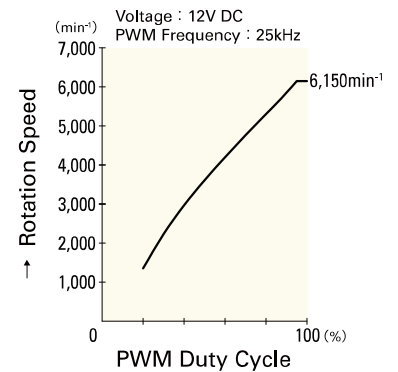

9WL0612P4H001

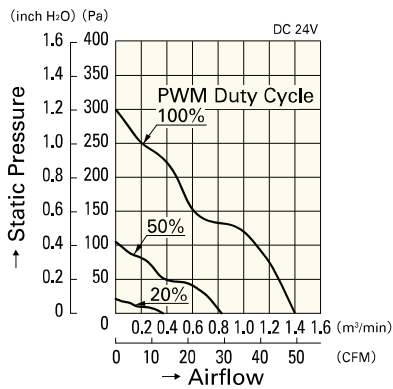

9WL0624P4S001

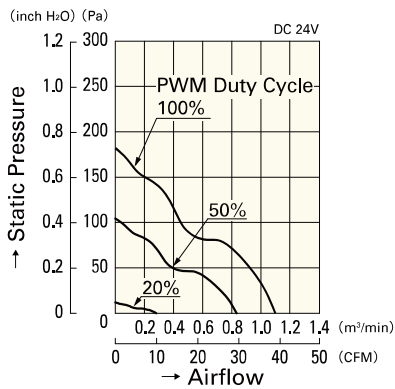

9WL0624P4J001

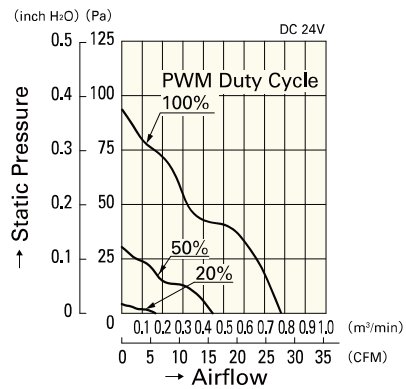

9WL0624P4H001

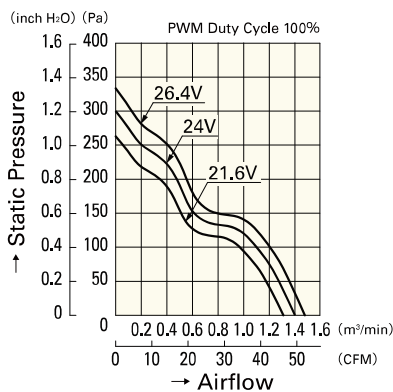

9WL0624P4S001

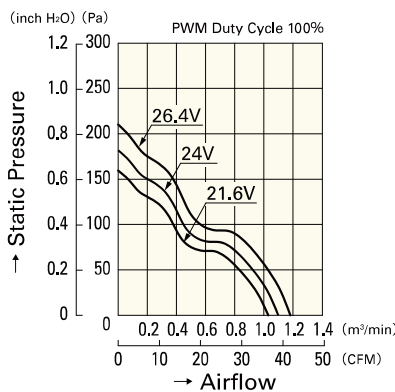

9WL0624P4J001

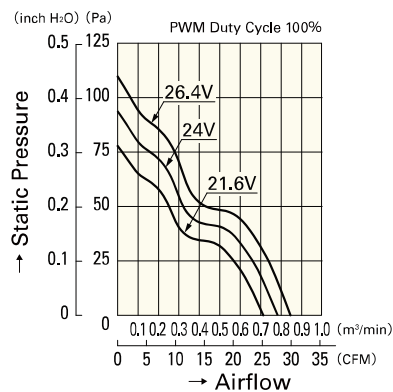

9WL0624P4H001

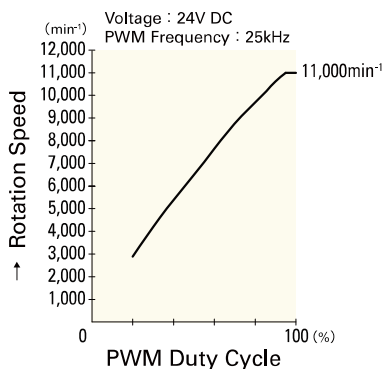

9WL0624P4S001

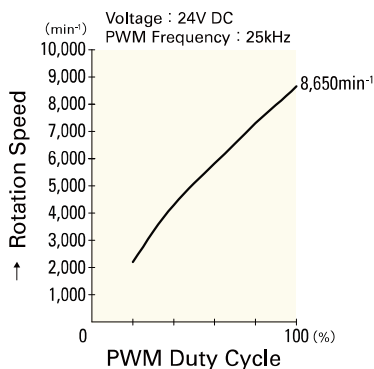

9WL0624P4J001

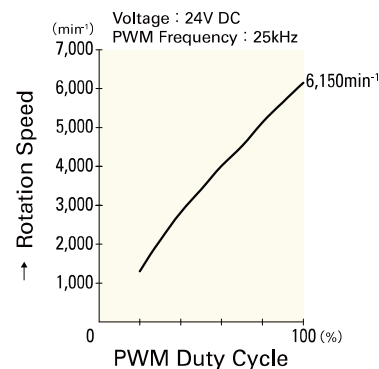

9WL0624P4H001