

40 mm sq.

San Ace 40



General Specifications

- Material Frame: Plastics (Flammability: UL94V-0),
Impeller: Plastics (Flammability: UL94V-1)
- Expected Life Refer to specifications (L10:Survival rate:90% at 60°C ,
rated voltage, and continuously run in a free air state)
- Lead Wire Inlet ⊕ red ⊖ black (Sensor) yellow (Control) brown
Outlet ⊕ orange ⊖ gray (Sensor) purple (Control) white
- Storage Temperature -30°C to +70°C (Non-condensing)

40×40×48mm [Mass : 80g] **9CRA type**

Specifications

The following nos. **have PWM controls and pulse sensors.**

Model No.	Rated Voltage [V]	Operating Voltage Range [V]	PWM duty cycle* [%]	Rated Current [A]	Rated Input [W]	Rated Speed [min ⁻¹]		Max. Airflow [m ³ /min] [CFM]		Max. Static Pressure [Pa] [inchH ₂ O]		SPL [dB(A)]	Operating Temperature [°C]	Expected Life [h]
						Inlet	Outlet							
9CRA0412P4K03	12	10.8 to 13.2	100	1.60	19.20	17,500	11,700	0.920	32.50	650.0	2.610	64	-20 to +70	40,000/60°C
			0	0.19	2.28	5,250	3,510	0.276	9.75	58.5	0.235	33		
9CRA0412P4J03			100	1.20	14.40	16,200	10,800	0.850	30.00	560.0	2.250	62		
			0	0.15	1.80	4,500	3,000	0.236	8.33	43.2	0.173	28		
9CRA0412P4G03			100	1.00	12.00	14,700	9,800	0.770	27.20	460.0	1.850	59		
			0	0.15	1.80	4,410	2,940	0.231	8.16	41.4	0.166	28		

*PWM Frequency : 25kHz

Other sensor specifications are available as options. Please refer to the index (p. 501).

Dimensions (unit: mm)

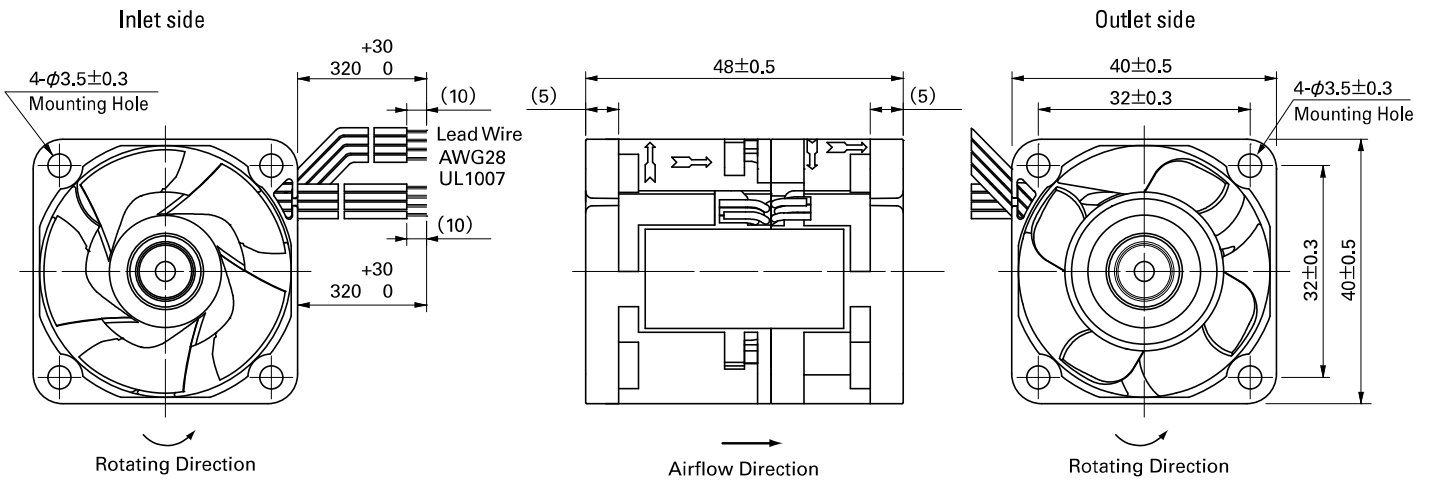

Reference Dimensions of mounting holes and vent opening (unit: mm)

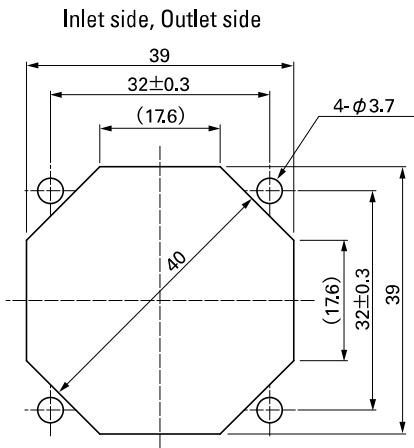

Options (unit: mm)

Finger Guards

Model : 109-059 Surface treatment : Nickel-chrome plating (silver)
: 109-059H : Cation electropainting (black)

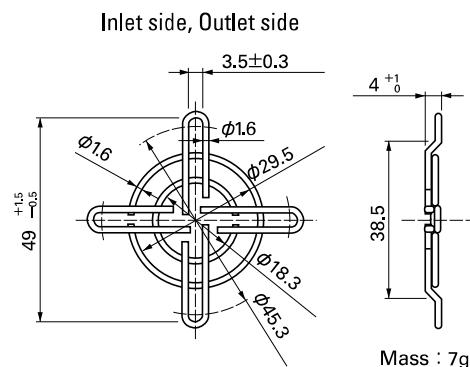

Airflow - Static Pressure Characteristics

PWM Duty Cycle

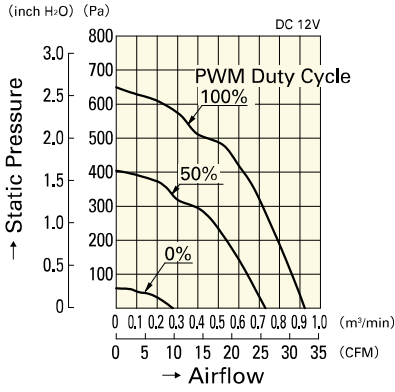

9CRA0412P4K03

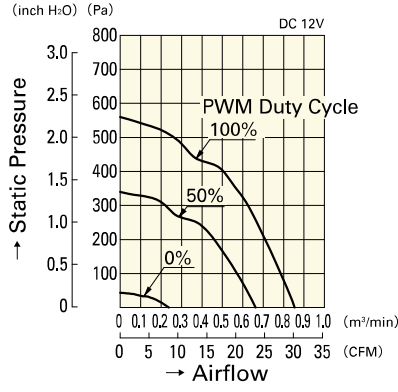

9CRA0412P4J03

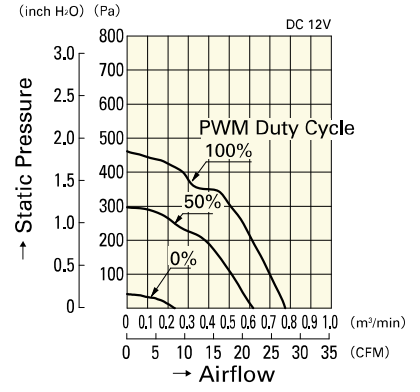

9CRA0412P4G03

Operating Voltage Range

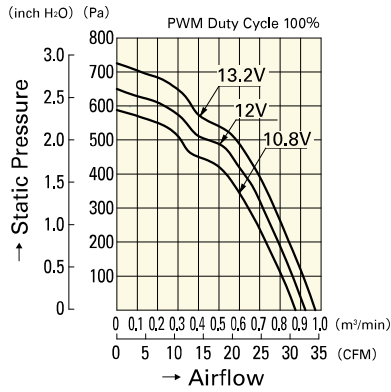

9CRA0412P4K03

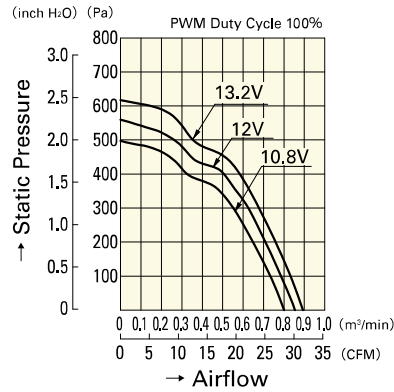

9CRA0412P4J03

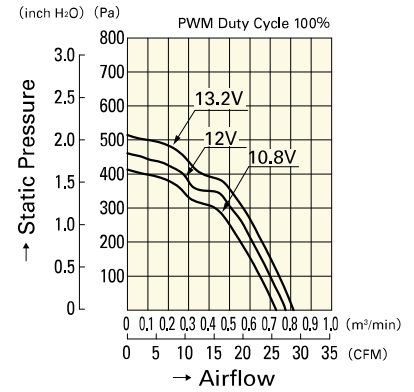

9CRA0412P4G03

PWM Duty - Speed Characteristics Example

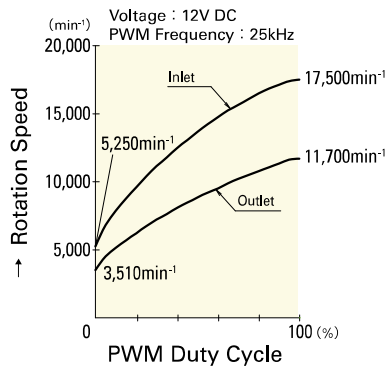

9CRA0412P4K03

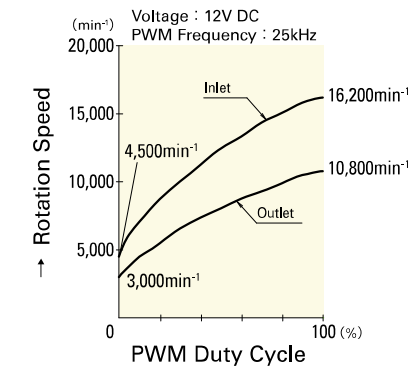

9CRA0412P4J03

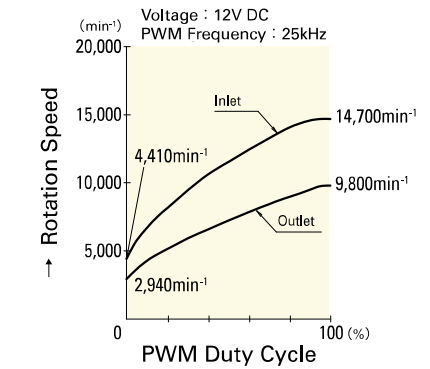

9CRA0412P4G03