

**92** mm sq.

# San Ace 92



## General Specifications

- Material ..... Frame: Plastics (Flammability: UL94V-0),  
Impeller: Plastics (Flammability: UL94V-1)
- Expected Life ..... Refer to specifications (L10:Survival rate:90% at 60°C ,  
rated voltage, and continuously run in a free air state)
- Lead Wire ..... ⊕red ⊖black (Sensor) yellow (Control) brown
- Storage Temperature ..... -30°C to +70°C (Non-condensing)

**92×92×38**mm [Mass : 250g] **9GV type** 

## Specifications

The following nos. **have PWM controls, pulse sensors, and ribs.** For ribless, append "1" to the model no.

Model No.	Rated Voltage [V]	Operating Voltage Range [V]	PWM duty cycle* [%]	Rated Current [A]	Rated Input [W]	Rated Speed [min <sup>-1</sup> ]	Max. Airflow [m <sup>3</sup> /min] [CFM]	Max. Static Pressure [Pa] [inchH <sub>2</sub> O]	SPL [dB(A)]	Operating Temperature [°C]	Expected Life [h]						
9GV0912P1G03	12	10.8 to 13.2	100	4.10	49.2	9,000	5.35 189.0	430.0 1.73	68	-20 to +70	40,000/60°C						
			0	0.33	4.0	2,900	1.72 60.8	44.6 0.18	37								
10.2 to 13.8		100	3.50	42.0	8,500	5.05 178.0	385.0 1.55	64	-10 to +70								
		0	0.29	3.5	2,700	1.60 56.5	38.8 0.16	34									
9GV0912P1H03		12	10.2 to 13.8	100	1.9	22.8	7,000	4.15 146.6	261 1.05			59	-10 to +70	40,000/60°C			
				0	0.16	1.92	2,200	1.3 45.9	25.7 0.1			31					
9GV0948P1H03	48		40.8 to 55.2	100	0.82	39.4	8,500	5.05 178.0	385.0 1.55	64	-20 to +70	40,000/60°C					
				0	0.14	6.7	4,000	2.37 83.7	85.2 0.34	45							
9GV0948P1F03			48	40.8 to 55.2	100	0.48	23.04	7,000	4.15 146.6	261 1.05					59	-10 to +70	40,000/60°C
					0	0.12	5.76	3,500	2.07 73.1	65.2 0.26					42		

\*PWM Frequency : 25kHz

Other sensor specifications are available as options. Please refer to the index (pp. 507 to 508).

## Dimensions (unit: mm) (With ribs)

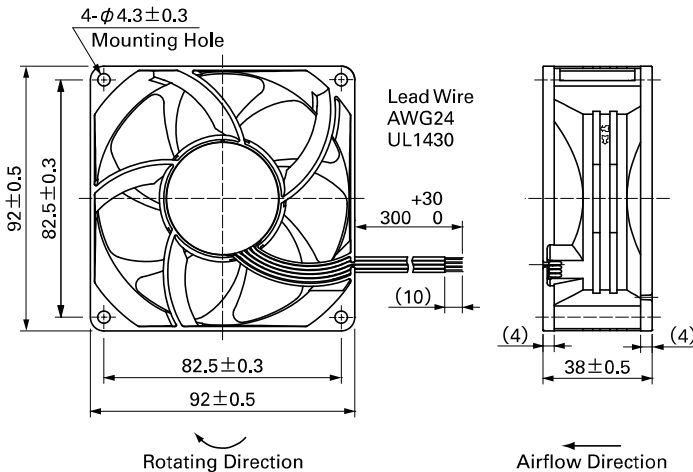

Reference Dimensions of Mounting Holes and Vent Opening (unit: mm)

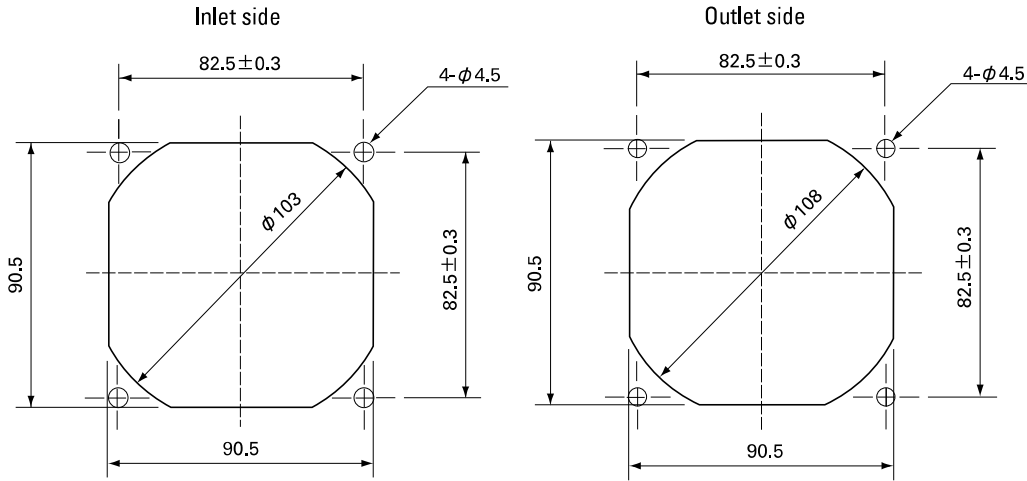

Options (unit: mm)

Finger Guards

Model : 109-099C Surface treatment : Nickel-chrome plating (silver) Color : Nickel-chrome plating (silver)

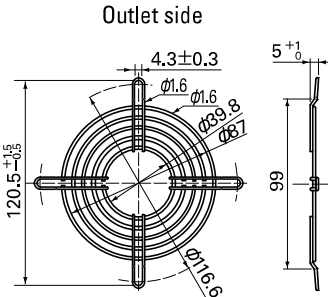

Mass : 22g

Resin Finger Guards

Model : 109-1001G

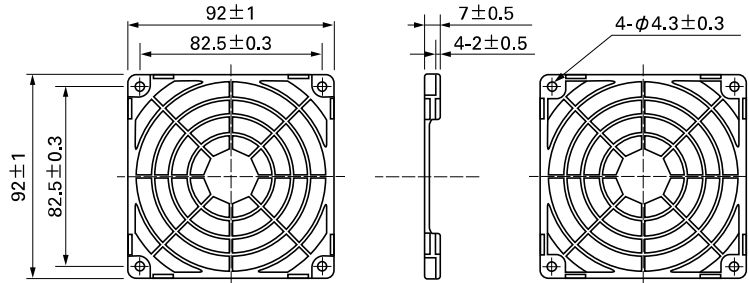

Mass : 12g

Model : 109-099E Surface treatment : Nickel-chrome plating (silver) Color : Nickel-chrome plating (silver)  
 : 109-099H : Cation electropainting (black)

Inlet side, Outlet side

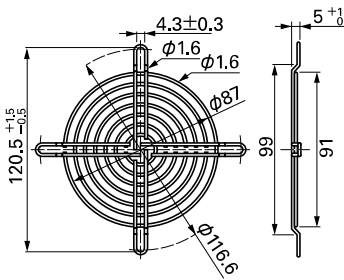

Mass : 29g

Resin Filter Kits

Model : 109-1001F13 (13PPI), 109-1001F20 (20PPI)  
 : 109-1001F30 (30PPI), 109-1001F40 (40PPI)

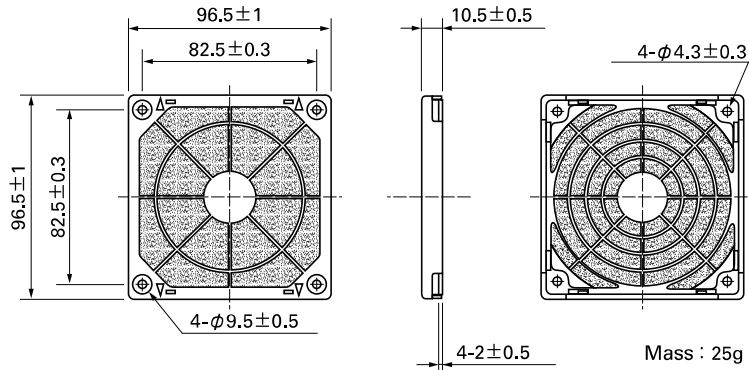

Mass : 25g

**92**mm sq.

**San Ace 92**

**92×92×38mm** [Mass : 250g]

**Airflow - Static Pressure Characteristics**

**PWM Duty Cycle**

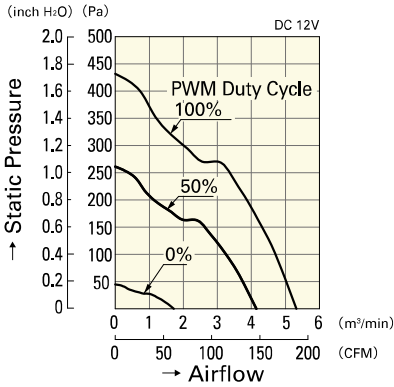

**9GV0912P1G03**

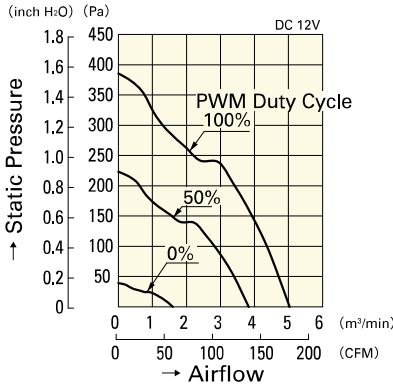

**9GV0912P1H03**

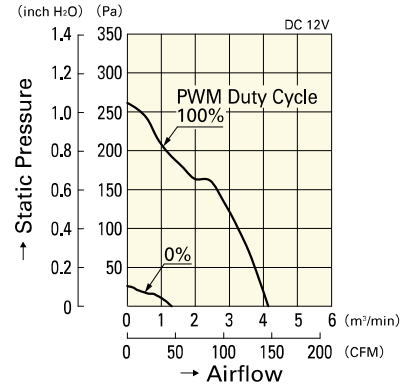

**9GV0912P1F03**

**Operating Voltage Range**

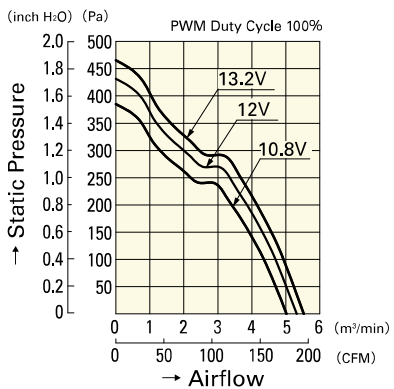

**9GV0912P1G03**

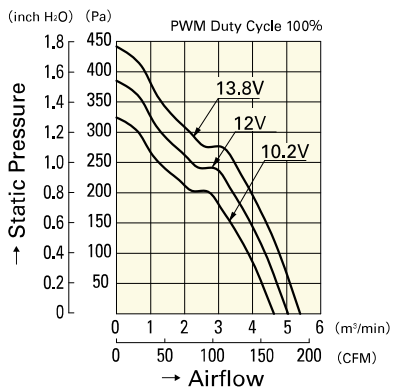

**9GV0912P1H03**

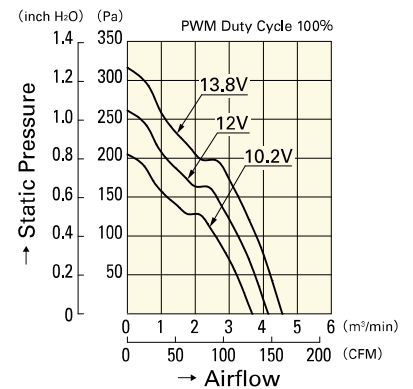

**9GV0912P1F03**

**PWM Duty - Speed Characteristics Example**

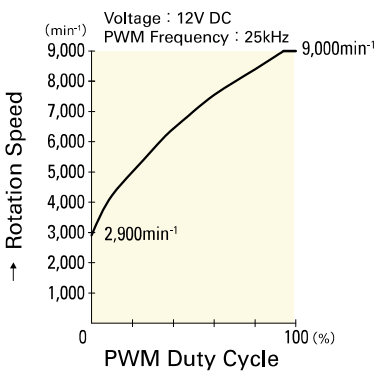

**9GV0912P1G03**

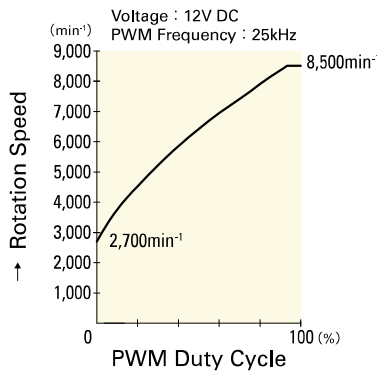

**9GV0912P1H03**

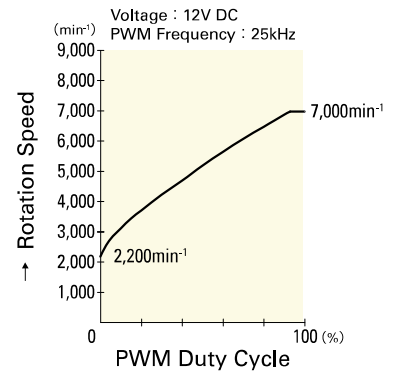

**9GV0912P1F03**

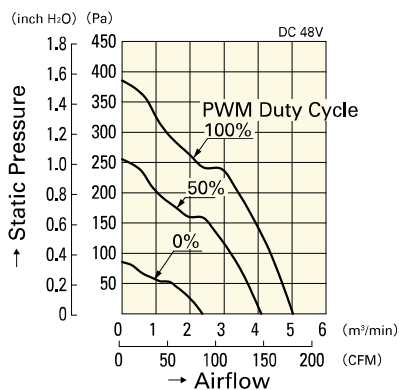

**9GV0948P1H03**

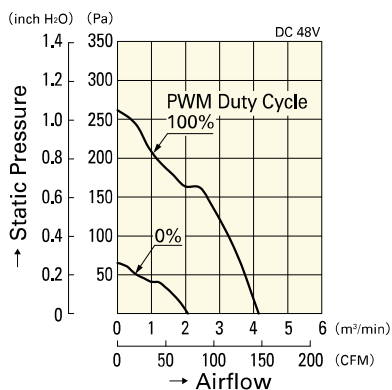

**9GV0948P1F03**

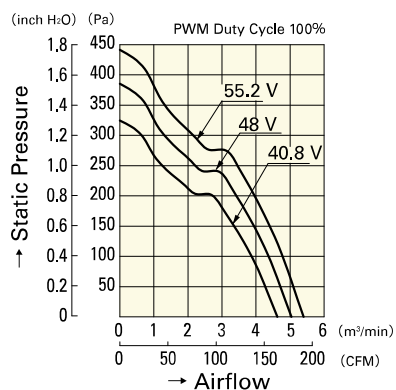

**9GV0948P1H03**

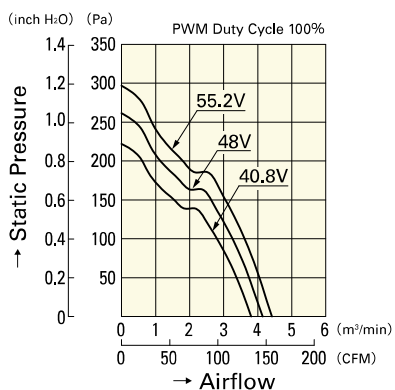

**9GV0948P1F03**

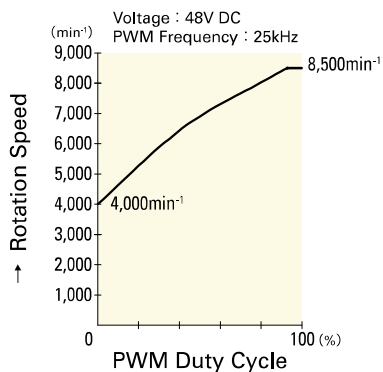

**9GV0948P1H03**

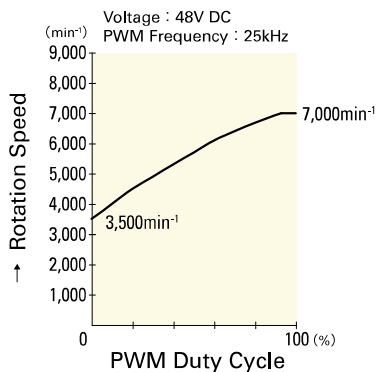

**9GV0948P1F03**